

Návod na montáž rámu výklopné postele - 120,140

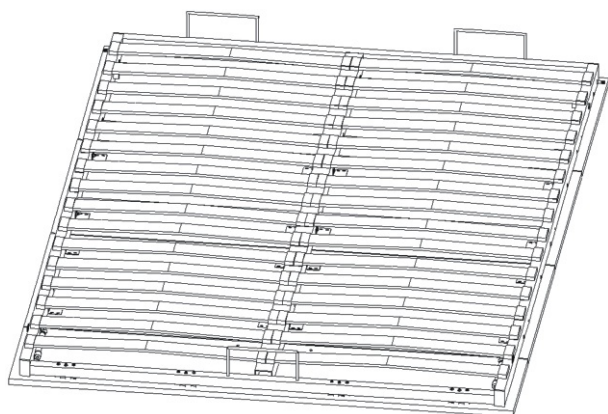

Šroub ozdobný 4x60 6x 	Šroub ozdobný 4x40 12x 	Šroub zápusťný 3x35 12x 	Úchyt dveří 50x40x20mm 24x
Podložka M4 24x 	Podložka M3 12x 	Matice samojistná M4 18x 	Matice samojistná M3 12x
Koncovka 50x30 4x 	Pant 60mm 4x 	Držák lamel 60x 	Lamely U 120-585mm U 140-685mm 30x

1. Rám boční pohled

Velmi důležité při montáži dodržet obsazení děr!

Varianta rámu 120: VS 1054, VS 3054

Varianta rámu 140: VS 1054, VS 3054

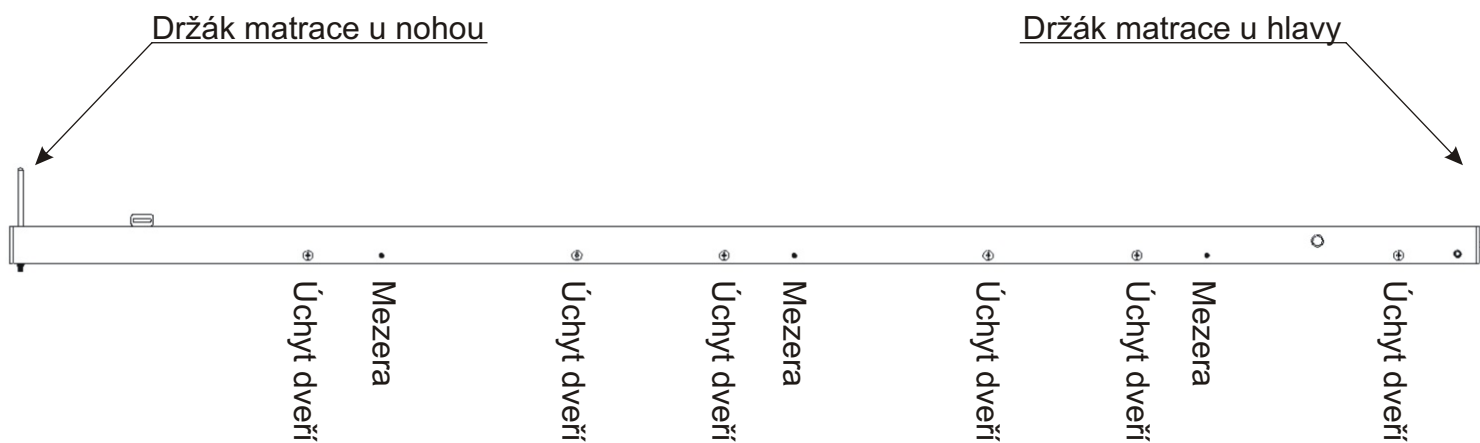

Varianta rámu VS 120: 21075,3075

Varianta rámu VS 140: 21058,21075,3075,4070

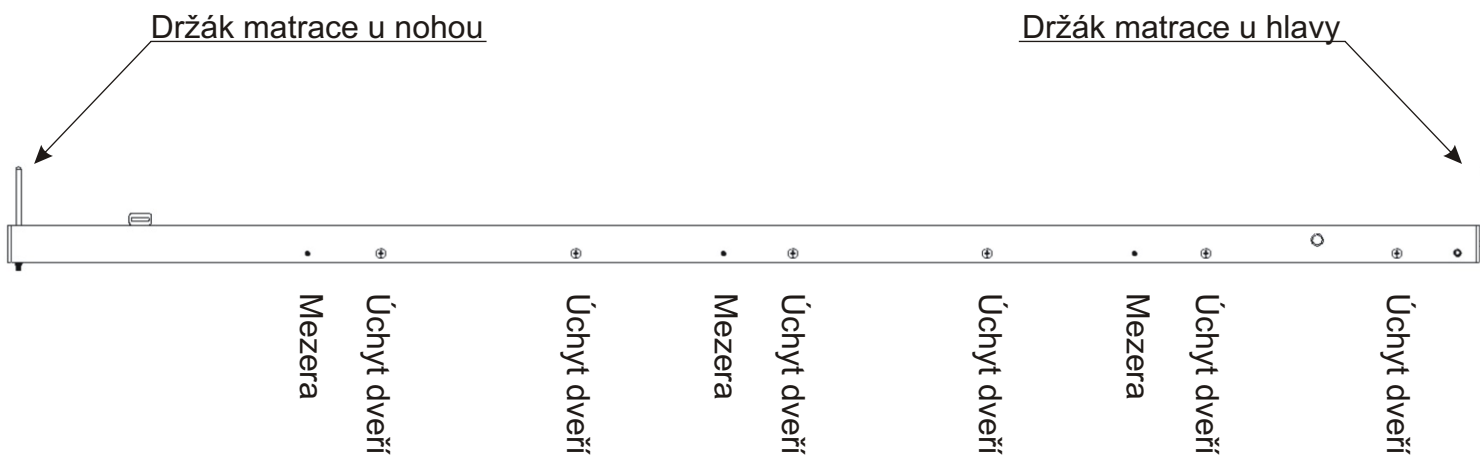

2. Nasazení panty

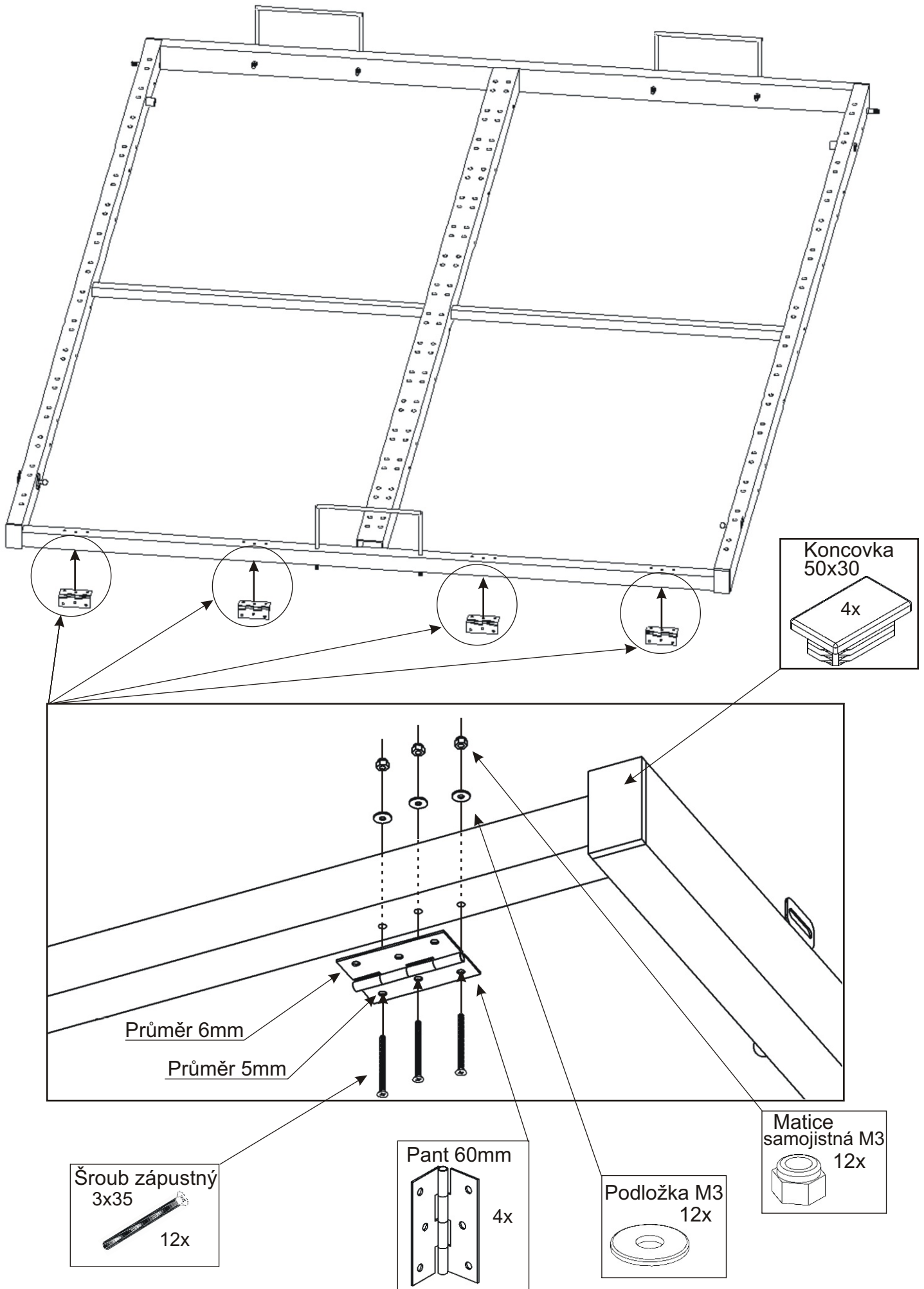

3. Držáky dveří

Matice
samojistná M4
6x



Podložka M4
12x

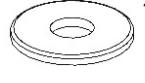

Úchyt dveří
50x40x20mm
12x

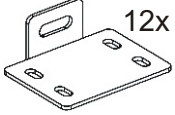

Šroub ozdobný
4x60
6x

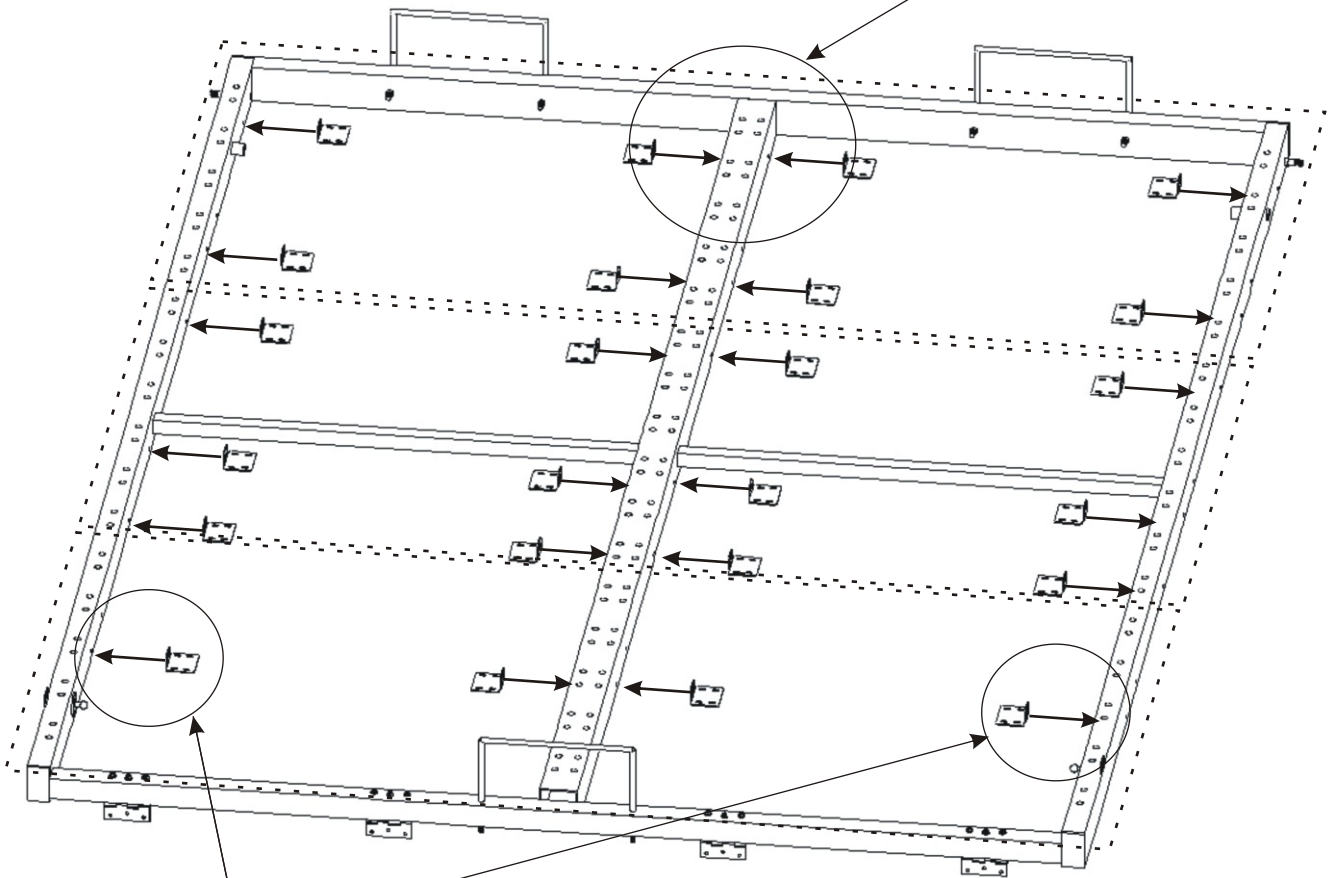

Šroub ozdobný
4x40
12x



Úchyt dveří
50x40x20mm
12x

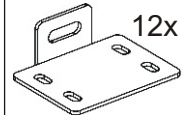

Podložka M4
12x

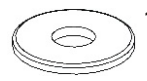

Matice
samojistná M4
12x

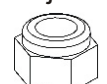

4. Nasazení lamel

Držáky natlučeme z obou stran na lamely

Lamely nasadíme až ke konci návodu na montáž kompletní výklopné postele!

Držák lamel
60x

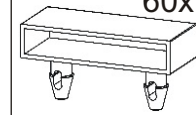

4.1.

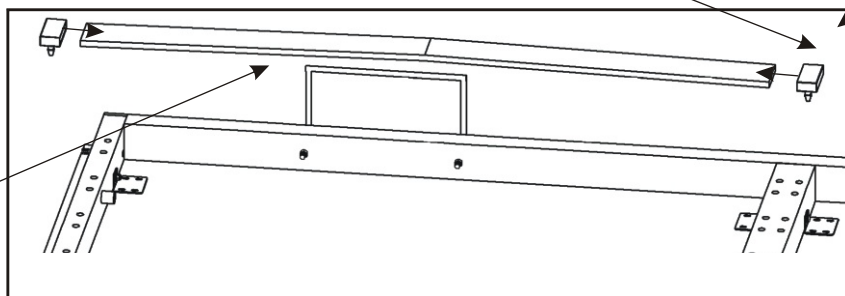

4.2.

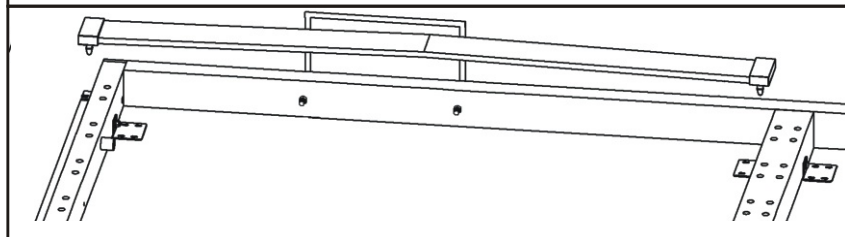

4.3.

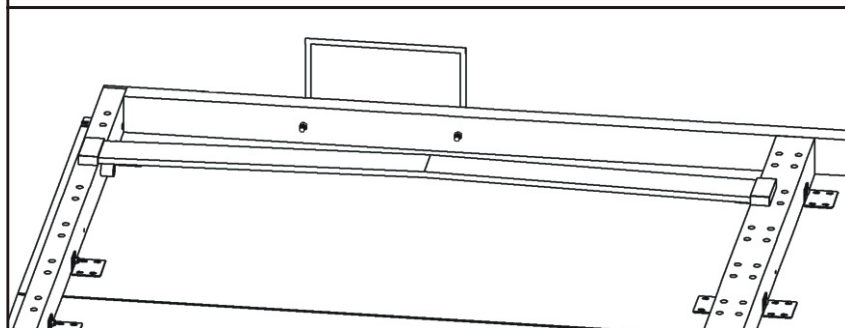

Lamely
U 120-585mm
U 140-685mm



30x

