

# K 40 koupelnová skříňka vysoká s košem

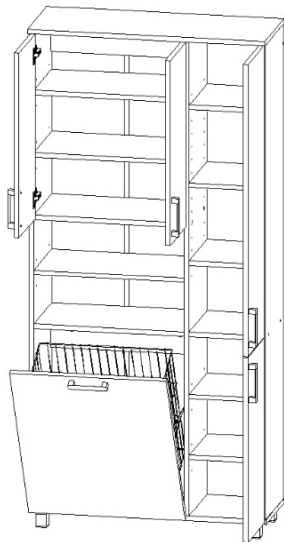
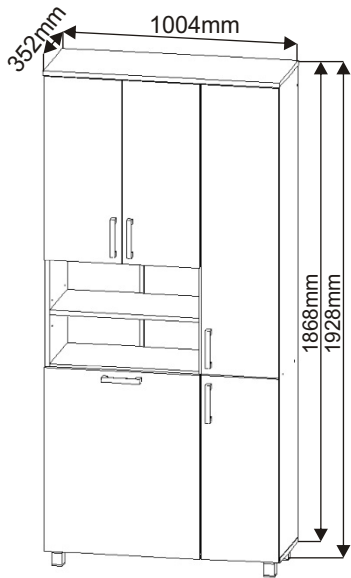

Naložený pant 8x 	Polonaložený pant 2x 	Úchytka plastová 5x  128mm	Šroub 4x30 k úchytce 10x 	Krytka 16x 
-------------------------	-----------------------------	-------------------------------------	---------------------------------	-------------------

Konfirmát 50mm 14x 	Hřebík 90x 	Vrut 4x16 40x 	Vrut 3,5x16 14x 	Kolík 35mm 53x 	Lepidlo 40ml 1x 10ml 1x 
---------------------------	-------------------	----------------------	------------------------	-----------------------	-----------------------------

Policové podpěrky 32x 	Držák koše 6x 	Závěs koše 2x 	Drátěný koš 510x290x510 1x 	H lišta 1682mm 1x 
------------------------------	----------------------	----------------------	-----------------------------------	--------------------------

### Varianta plastové nohy:

Plastová noha 60mm 4x 	Vrut 3,5x16 16x 
------------------------------	------------------------

### Varianta zavěšení na zeď:

Hmoždinka ø12 6x 	Vrut 6x70 6x 	Vrut 4x20 4x 	Závěsné kování Bystrica 52x50x39mm 2x 
-------------------------	---------------------	---------------------	--

1.

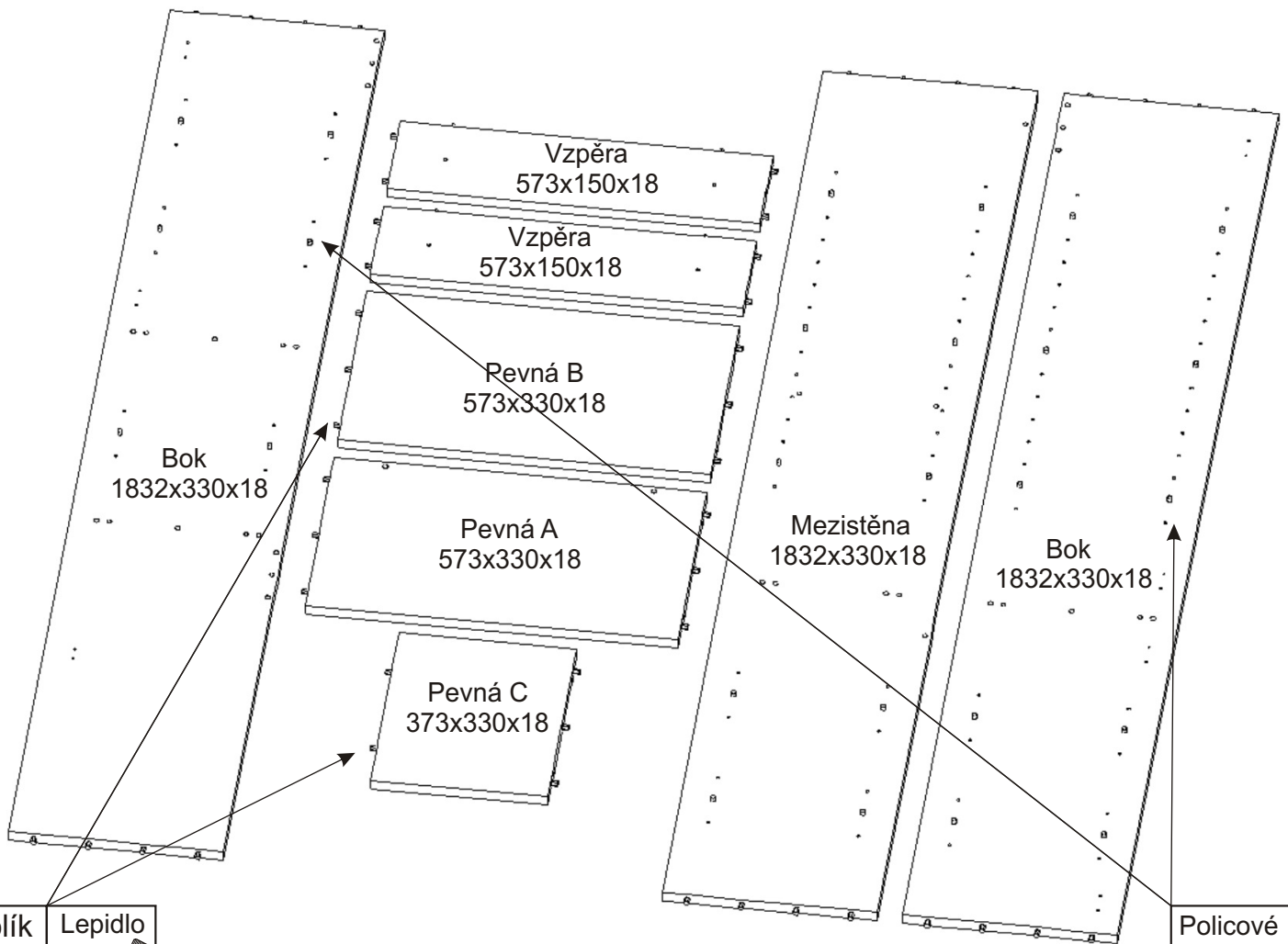

Kolík 35mm 53x 	Lepidlo 
-----------------------	-------------

Policové podpěrky 32x 
------------------------------

2.

Polonaložený pant

Vrut 4x16

2x

4x

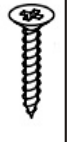
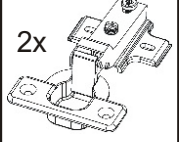

Dveře 713x296x18

Dveře 713x296x18

Dveře 1126x396x18

Dveře 713x596x18

Dveře 713x396x18

Naložený pant

Vrut 4x16

8x

16x

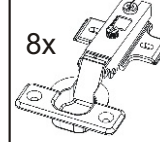

Úchytka plastová

Šroub 4x30 k úchytce

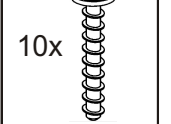
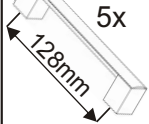

3.

Vzpěra 573x150x18

Pevná B 573x330x18

Pevná A 573x330x18

Vzpěra 573x150x18

Pevná C 373x330x18

Bok 1832x330x18

Mezistěna 1832x330x18

Bok 1832x330x18

Lepidlo

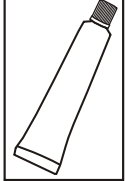

Konfirmát 50mm

Krytka

14x

12x



4.

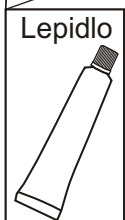
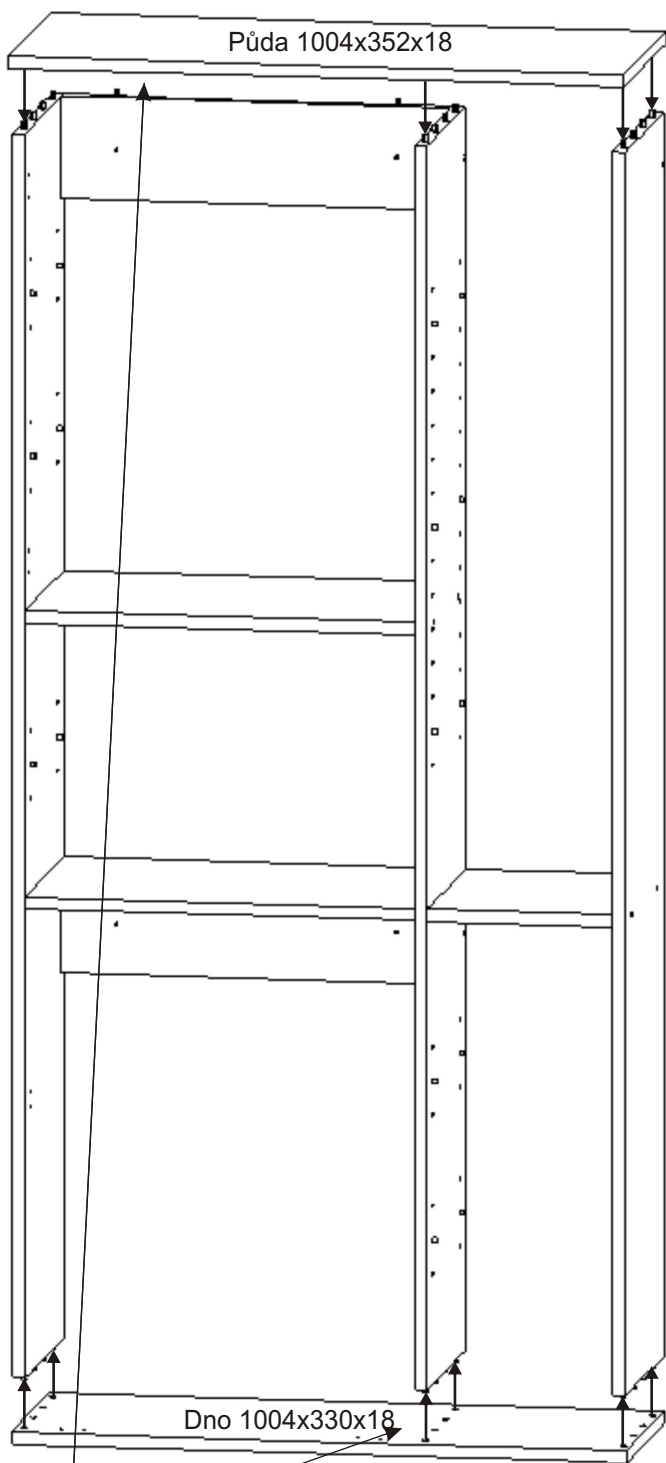

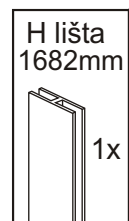
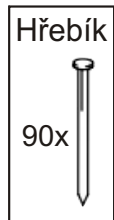
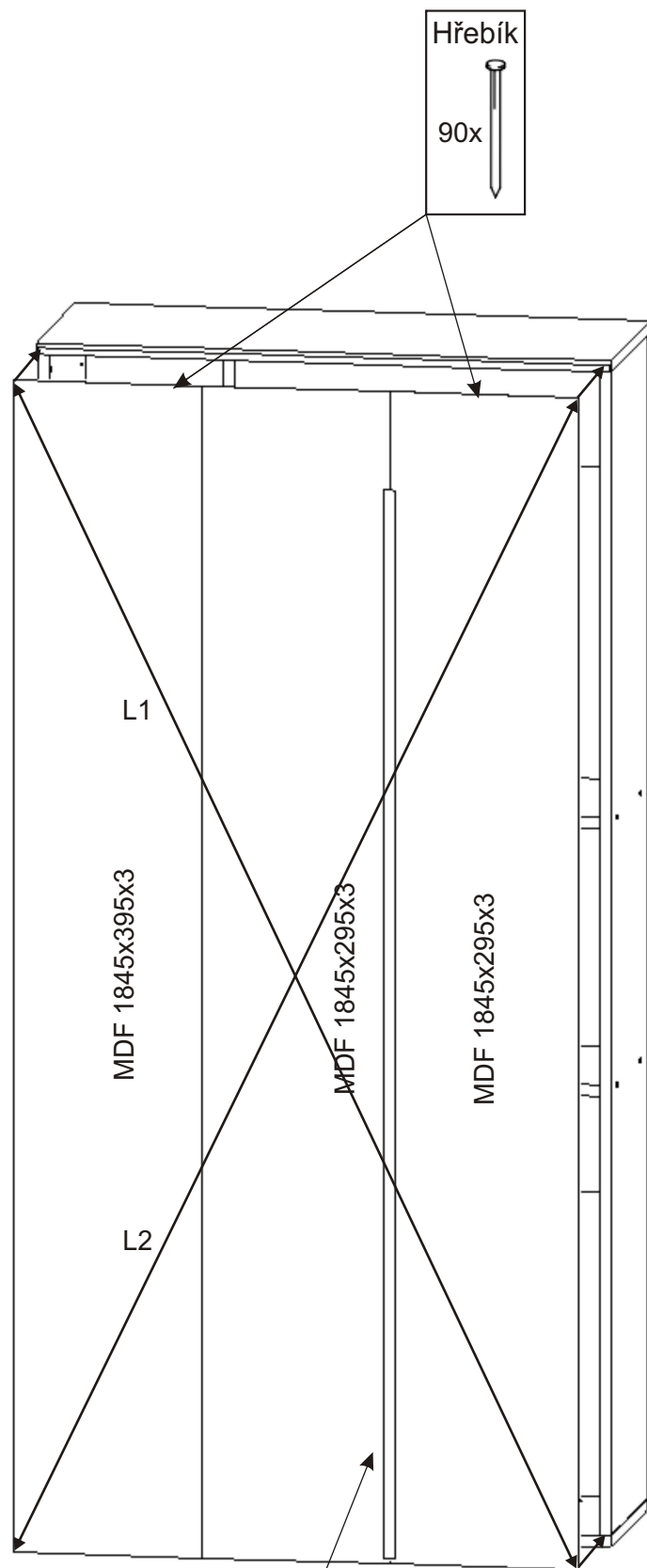

5.

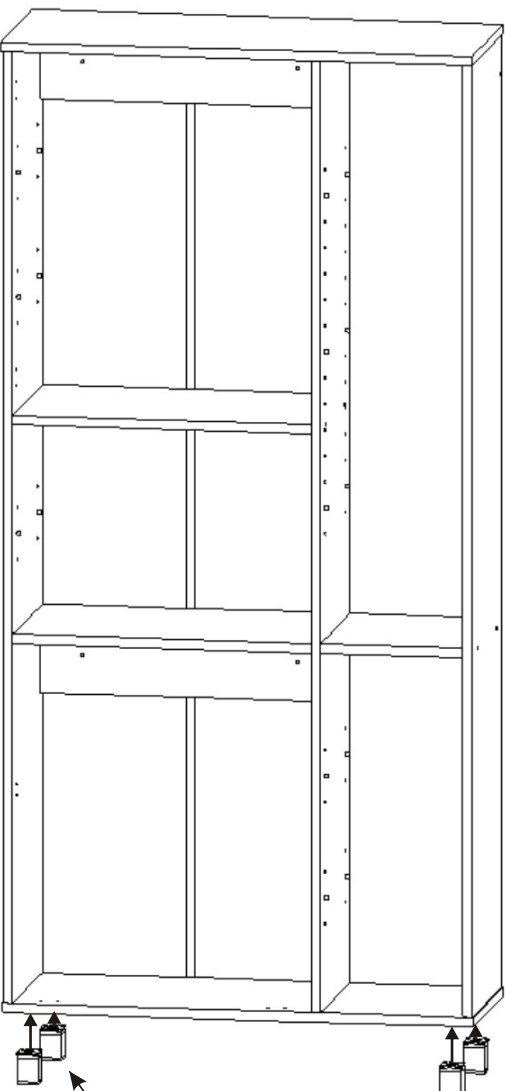

L1 = L2

### 6.A. Varianta plastové nohy





<p>Plastová noha 60mm</p> <p>4x</p> 	<p>Vrut 3,5x16</p> <p>16x</p> 
---	---

### 6.B. Varianta zavěšení na zeď:

U této varianty skříň připevníme ke zdi pomocí hmoždinek.

Hmoždinka  
ø12  
6x



<p>Vrut 6x70</p> <p>4x</p> 	<p>Krytka</p> <p>4x</p> 
---	--

Do zad v MDF sololitu provrtáme otvor minimálně ø8mm.

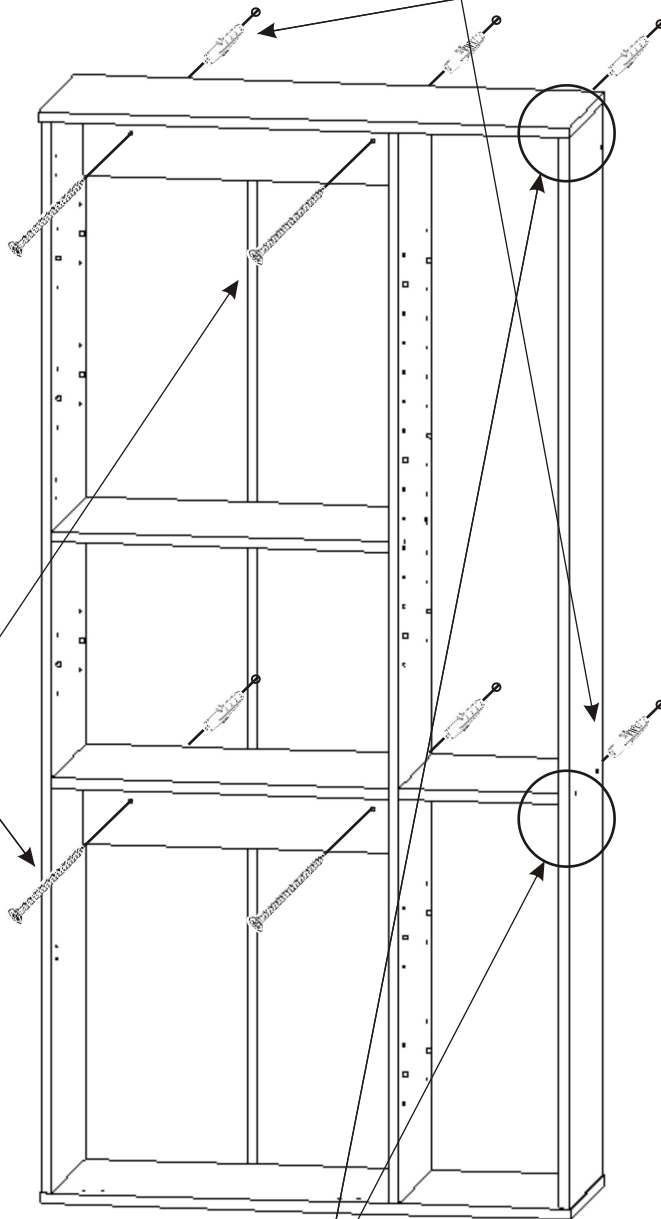

6.1.

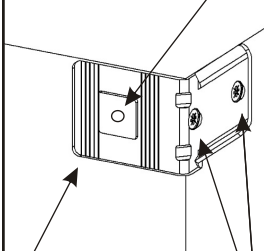

Závěsné kování Bystrica

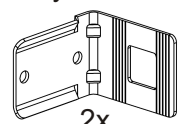

6.2.

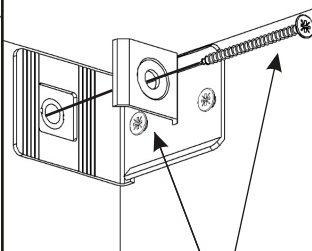

Vrut 4x20

4x



Vrut 6x70

2x



Závěsné kování Bystrica-podložka

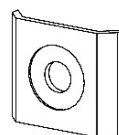

6.3.

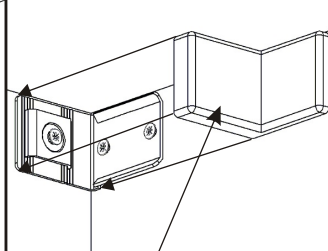

Závěsné kování Bystrica - krytka

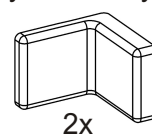

7.

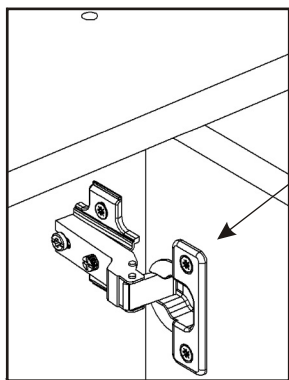

Dveře s polonaloženými panty.  
Je důležité neprohodit typy pantů.

Vrut  
4x16  
20x

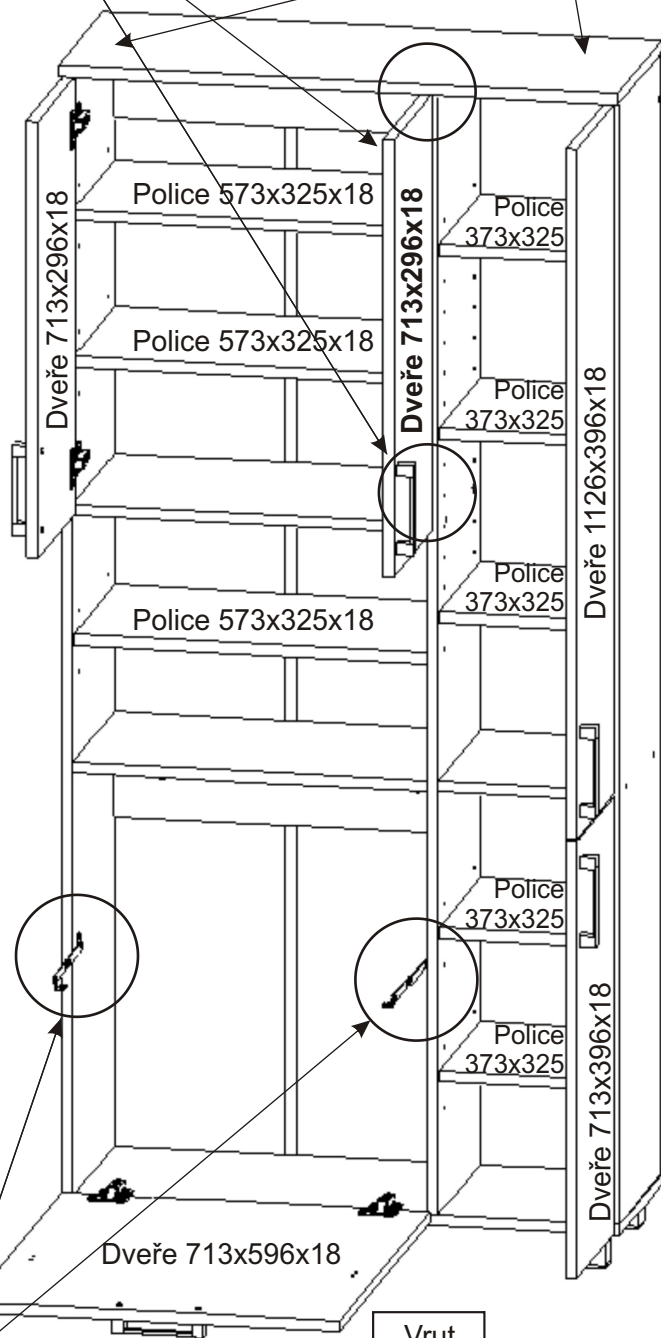
Vrut  
3,5x16  
4x



Závěs koše  
2x

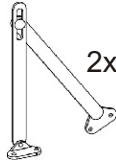
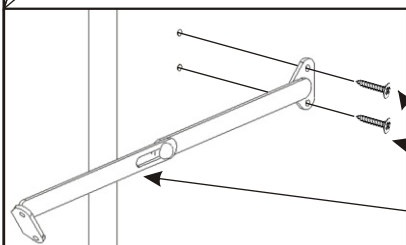

8.

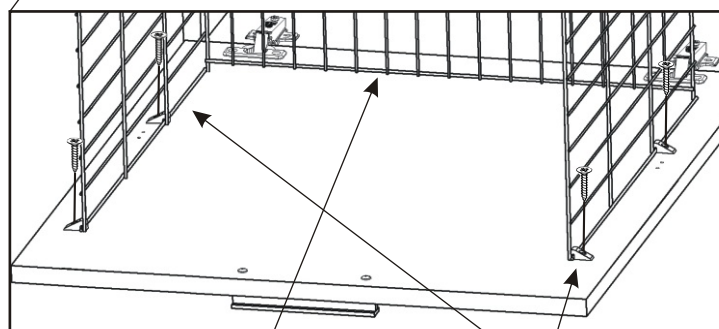
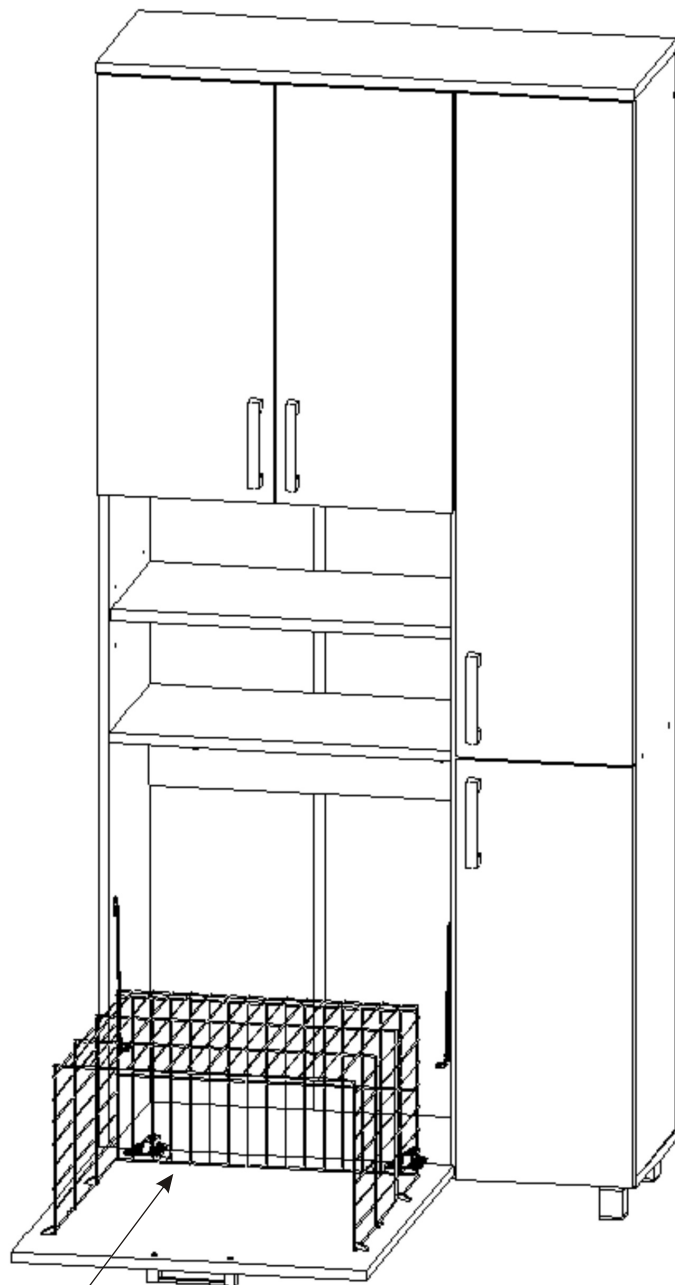

Drátěný koš  
510x290x510  
1x

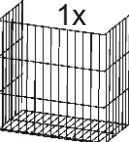

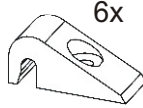
Držák koše  
6x  
Vrut  
3,5x16  
6x

9.

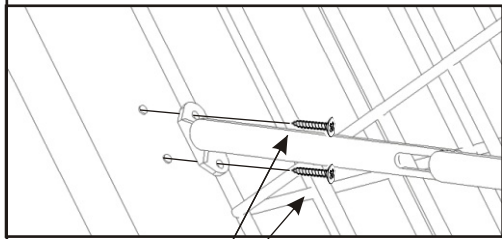

Vrut  
3,5x16  
4x

